

imc ARGUSfit

Getting started

Edition 1 - 2023-06-06



© 2023 imc Test & Measurement GmbH

imc Test & Measurement GmbH • Voltastr. 5 • 13355 Berlin • Germany

Disclaimer of liability

The contents of this documentation have been carefully checked for consistency with the hardware and software systems described. Nevertheless, it is impossible to completely rule out inconsistencies, so that we decline to offer any guarantee of total conformity.

We reserve the right to make technical modifications of the systems.

Copyright

© 2023 imc Test & Measurement GmbH, Germany

This documentation is the intellectual property of imc Test & Measurement GmbH. imc Test & Measurement GmbH reserves all rights to this documentation. The applicable provisions are stipulated in the "imc Software License Agreement".

The software described in this document may only be used in accordance with the provisions of the "imc Software License Agreement".

Open Source Software Licenses

Some components of imc products use software which is licensed under the GNU General Public License (GPL). Details are available in the About dialog.

A list of the open source software licenses for the imc measurement devices is located on the imc STUDIO/imc WAVE/imc STUDIO Monitor installation medium in the folder "*Products\imc DEVICES\OSS*" or "*Products\imc DEVICEcore\OSS*" or "*Products\imc STUDIO\OSS*". If you wish to receive a copy of the GPL sources used, please contact our Hotline.

Notes regarding this document

This document is an excerpt from the manual of the device / the module.

This document provides important notes on using the device / the module. Safe working is conditional on compliance with all safety measures and instructions provided. The manual is to be used as a kind of reference book. You can skip the description of the modules you do not have.

Additionally, all accident prevention and general safety regulations pertinent to the location at which the device is used must be adhered to.

These instructions exclusively describe the device, **not how to operate** it by means of **the software!**

If you have any questions as to whether you can set up the device / module in the intended environment, please contact the imc hotline. The measurement system has been designed, manufactured and unit-tested with all due care and in accordance with the safety regulations before delivery and has left the factory in perfect condition. In order to maintain this condition and to ensure safe operation, the user must observe the notes and warnings contained in this chapter and in the specific sections applicable to the concrete device. Never use the device outside the specification.

This will protect you and prevent damage to the device.

Special notes

Warning

Warnings contain information that must be observed to protect the user from harm or to prevent damage to property.

Note

Notes denote useful additional information on a particular topic.

Reference

A reference in this document is a reference in the text to another text passage.

Table of contents

1 General introduction	5
1.1 imc Customer Support / Hotline	5
1.2 Legal notices	5
1.3 Explanation of symbols	8
1.4 Latest changes in content	9
2 Safety	10
3 Assembly and connection	13
3.1 After unpacking... ..	13
3.2 Before commissioning	13
3.3 Notes on connecting	14
3.3.1 Precautions for operation	14
3.3.2 Click mechanism	15
3.3.3 Power supply	16
3.3.4 Fiber Converter	18
3.3.5 UPS-NiMH	19
3.3.6 Powering on	23
3.3.7 Powering off	23
3.3.8 Remote control of the base unit	23
3.3.9 Internal data carrier	24
3.3.10 LED display ARGFT-BASE	27
4 Maintenance and servicing	28
4.1 Maintenance and servicing	28
4.2 Cleaning	28
4.3 Storage	28
4.4 Transport	28
5 Start of operation Software / Firmware	29
5.1 Installation - Software	29
5.1.1 System requirements	29
5.2 Connect the device	29
5.3 Connecting via LAN in three steps	30
5.4 Firmware update	32
6 Pin configuration	34
6.1 Power	34
6.2 Remote	34
6.3 Base Unit	35
6.3.1 GPS	35
6.3.2 CANSAS	35
6.4 Measurement Modules	36
6.4.1 UTI-6	36
Index	38

1 General introduction

1.1 imc Customer Support / Hotline

If you have problems or questions, please contact our Customer Support/Hotline:

imc Test & Measurement GmbH

Hotline (Germany): **+49 30 467090-26**

E-Mail: hotline@imc-tm.de

Internet: <https://www.imc-tm.com>

International partners

For our international partners see <https://www.imc-tm.com/distributors/>.

Tip for ensuring quick processing of your questions:

If you contact us **you would help us**, if you know the **serial number of your devices** and the **version info of the software**. This documentation should also be on hand.

- The device's serial number appears on the nameplate.
- The program version designation is available in the About-Dialog.

1.2 Legal notices

Quality Management



imc Test & Measurement GmbH holds DIN-EN-ISO-9001 certification since May 1995. You can download the CE Certification, current certificates and information about the imc quality system on our website: <https://www.imc-tm.com/quality-assurance/>.

imc Warranty

Subject to the general terms and conditions of imc Test & Measurement GmbH.

Liability restrictions

All specifications and notes in this document are subject to applicable standards and regulations, and reflect the state of the art well as accumulated years of knowledge and experience. The contents of this document have been carefully checked for consistency with the hardware and the software systems described. Nevertheless, it is impossible to completely rule out inconsistencies, so that we decline to offer any guarantee of total conformity. We reserve the right to make technical modifications of the systems.

The manufacturer declines any liability for damage arising from:

- failure to comply with the provided documentation,
- inappropriate use of the equipment.

Please note that all properties described refer to a closed measurement system and not to its individual slices. Attach covers over the [module connectors](#)¹⁴ on the upper and lower sides.

Guarantee

Each device is subjected to a 24-hour "burn-in" before leaving imc. This procedure is capable of detecting almost all cases of early failure. This does not, however, guarantee that a component will not fail after longer operation. Therefore, all imc devices are granted liability for a period of two years. The condition for this guarantee is that no alterations or modifications have been made to the device by the customer.

Unauthorized intervention in the device renders the guarantee null and void.

Notes on radio interference suppression

imc ARGUSfit devices satisfy the EMC requirements for an use in industrial settings.

Any additional products connected to the product must satisfy the EMC requirements as specified by the responsible authority (within Europe¹) in Germany the BNetzA - "Bundesnetzagentur" (formerly BMPT-Vfg. No. 1046/84 or No. 243/91) or EC Guidelines 2014/30/EU. All products which satisfy these requirements must be appropriately marked by the manufacturer or display the CE certification marking.

Products not satisfying these requirements may only be used with special approval of the regulating body in the country where operated.

All lines connected to the imc ARGUSfit should not be longer than 30 m and they should be shielded and the shielding must be grounded.

Note

The EMC tests were carried out using shielded and grounded input and output cables with the exception of the power cord. Observe this condition when designing your experiment to ensure high interference immunity and low jamming.

¹ If you are located outside Europe, please refer the appropriate EMC standards used in the country of operation.

Cables and leads

In order to comply with the value limits applicable to Class B devices according to part 15 of the FCC regulations, all signal leads connected to imc ARGUSfit must be shielded.

Unless otherwise indicated, no connection leads may be long leads (< 30 m) as defined by the standard IEC 61326-1. LAN-cables (RJ 45) and CAN-Bus cables are excepted from this rule.

Only cables with suitable properties for the task (e.g. isolation for protection against electric shock) may be used.

ElektroG, RoHS 2, WEEE, CE

The imc Test & Measurement GmbH is registered with the authority as follows:

WEEE Reg. No. DE 43368136

valid from 24.11.2005



Reference

<https://www.imc-tm.com/elekrog-rohs-weee/> and <https://www.imc-tm.com/ce-conformity/>

FCC-Notice

This product has been tested and found to comply with the limits for a Class B digital device, pursuant to Part 15 of the FCC Rules. These limits are designed to provide reasonable protection against harmful interference in a residential installation. This equipment generates, uses, and can radiate radio frequency energy and, if not installed and used in accordance with the instructions, may cause harmful interference to radio communications. However, there is no guarantee that interference will not occur in a particular installation. If this equipment does cause harmful interference to radio or television reception, which can be determined by turning the equipment on and off, the user is encouraged to try to correct the interference by one or more of the following measures:

- Reorient or relocate the receiving antenna.
- Increase the separation between the equipment and the receiver.
- Connect the equipment into an outlet on a circuit different from that to which the receiver is connected.
- Consult our imc Hotline or an experienced technician for help.

Modifications

The FCC requires the user to be notified that any changes or modifications made to this product that are not expressly approved by imc may void the user's authority to operate this equipment.

1.3 Explanation of symbols



CE Conformity

see CE [chapter 1.2](#)



No household waste

Please do not dispose of the electrical/electronic device with household waste, but at the appropriate collection points for electrical waste, see also [chapter 1.2](#).

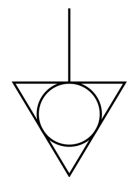

Potential compensation

Connection for potential compensation



Grounding

Connection for grounding (general, without protective function)



Protective connection

Connection for the protective conductor or grounding with protective function



Attention! General danger zone!

This symbol indicates a dangerous situation;
Since there is insufficient space for indicating the rated quantity at the measuring inputs, refer to this manual for the rated quantities of the measuring inputs before operation.



Attention! Injuries from hot surfaces!

Surfaces whose temperatures can exceed the limits under certain circumstances are denoted by the symbol shown at left.



ESD-sensitive components (device/connector)

When handling unprotected circuit boards, take suitable measures to protect against ESD (e.g. insert/remove ACC/CANFT-RESET).



Possibility of electric shock

The warning generally refers to high measurement voltages or signals at high potentials and is located on devices suitable for such measurements. The device itself does not generate dangerous voltages.



DC, Direct Current

Supply of the device via a DC voltage source (in the specified voltage range)



RoHS of the PR China

The limits for hazardous substances in electrical/electronic equipment applicable in the PRC are identical to those in the EU. The restrictions are complied with (see [chapter 1.2](#)⁵). A corresponding "China-RoHS" label is omitted for formal/economic reasons. Instead, the number in the symbol indicates the number of years in which no hazardous substances are released. (This is guaranteed by the absence of named substances).



Observe the documentation

Read the documentation before starting work and/or operating.

1.4 Latest changes in content

Please help us to improve our documentation:

- Which terms or descriptions are incomprehensible?
- What additions and enhancements you suggest?
- Where have material mistakes slipped in?
- Which spelling, translation or typing errors have you found?

Responses and other feedback should be directed to the Hotline

Completions and error remedies in the manual edition 1

Chapter	Change

2 Safety

This section provides an overview of all important aspects of protection of the users for reliable and trouble-free operation. Failure to comply with the instructions and protection notes provided here can result in serious danger.

Responsibility of the operator

imc ARGUSfit is for use in commercial applications. The user is therefore obligated to comply with legal regulations for work safety.

Along with the work safety procedures described in this document, the user must also conform to regulations for safety, accident prevention and environmental protection which apply to the work site. If the product is not used in a manner specified by the manufacturer, the protection supported by the product may be impaired.

The user must also ensure that any personnel assisting in the use of the imc ARGUSfit have also read and understood the content of this document.

Operating personnel

This document identifies the following qualifications for various fields of activity:

- *Users of measurement engineering*: Fundamentals of measurement engineering. Basic knowledge of electrical engineering is recommended. Familiarity with computers and the Microsoft Windows operating system. Users must not open or structurally modify the measurement device.
- *Qualified personnel* are able, due to training in the field and to possession of skills, experience and familiarity with the relevant regulations, to perform work assigned while independently recognizing any hazards.



Warning

- **Danger of injury due to inadequate qualifications!**
- Improper handling may lead to serious damage to personnel and property. When in doubt, consult qualified personnel.
- Work which may only be performed by trained imc personnel may not be performed by the user. Any exceptions are subject to prior consultation with the manufacturer and are conditional on having obtained corresponding training.

Special hazards

This segment states what residual dangers have been identified by the hazard analysis. Observe the safety notes listed here and the warnings appearing in subsequent chapters of this manual in order to reduce health risks and to avoid dangerous situations. Existing ventilation slits on the sides of the device must be kept free to prevent heat accumulation inside the device. Please operate the device only in the intended position of use if so specified.

Danger



Lethal danger from electric current!

- Contact with conducting parts is associated with immediate lethal danger.
- Damage to the insulation or to individual components can be lethally dangerous.

Therefore:

- In case of damage to the insulation, immediately cut off the power supply and have repair performed.
- Work on the electrical equipment must be performed exclusively by expert electricians.
- During all work performed on the electrical equipment, it must be deactivated and tested for static potential.

Injuries from hot surfaces!



- Devices from imc are designed so that their surface temperatures do not exceed limits stipulated in EN 61010-1 under normal conditions.

Therefore:

- Surfaces whose temperature can exceed the limits under circumstances are denoted by the symbol shown at left.

Industrial safety

We certify that imc ARGUSfit in all product configuration options corresponding to this documentation conforms to the directives in the accident prevention regulations in "Electric Installations and Industrial Equipment" (DGUV Regulation 3)*. This confirmation applies exclusively to devices of the imc ARGUS series, but not to all other components included in the scope of delivery.

This certification has the sole purpose of releasing imc from the obligation to have the electrical equipment tested prior to first use (§ 5 Sec. 1, 4 of DGUV Regulation 3). This does not affect guarantee and liability regulations of the civil code.

* previously BGV A3.

Observe notes and warnings

Devices from imc have been carefully designed, assembled and routinely tested in accordance with the safety regulations specified in the included certificate of conformity and has left imc in perfect operating condition. To maintain this condition and to ensure continued danger-free operation, the user should pay particular attention to the remarks and warnings made in this chapter. In this way, you protect yourself and prevent the device from being damaged.

Read this document before turning on the device for the first time carefully.

Warning

Before touching the device sockets and the lines connected to them, make sure static electricity is diverted to ground. Damage arising from electrostatic discharge is not covered by the warranty.

3 Assembly and connection

3.1 After unpacking...

Check the delivered system immediately upon receiving it for completeness and for possible transport damage. In case of damage visible from outside, proceed as follows:

- Do not accept the delivery or only accept it with reservations
- Note the extent of the damage on the packing documents or on the delivery service's packing list.
- Begin the claims process.

For an overview of the accessories supplied as standard, please refer to the data sheet of the supplied ARGUSfit module. Check the accessories for completeness.

Note

File a claim about every fault as soon as it is detected. Claims for damages can only be honored within the stated claims period.

3.2 Before commissioning

Condensation may form on the circuit boards when the device is moved from a cold environment to a warm one. In these situations, always wait until the device warms up to room temperature and is completely dry before turning it on. The acclimatization period should take about 2 hours.

Ambient temperature

The limits of the ambient temperature cannot be strictly specified because they depend on many factors of the specific application and environment, such as air flow/convection, heat radiation balance in the environment, contamination of the housing / contact with media, mounting structure, system configuration, connected cables, operating mode, etc. This is taken into account by specifying the operating temperature instead. Furthermore, it is not possible to predict any sharp limits for electronic components. Basically, reliability decreases when operating under extreme conditions (forced ageing). The operating temperature data represent the extreme limits at which the function of all components can still be guaranteed.

3.3 Notes on connecting

3.3.1 Precautions for operation

Certain ground rules for operating the system, aside from reasonable safety measures, must be observed to prevent danger to the user, third parties, the device itself and the measurement object. These are the use of the system in conformity to its design, and the refraining from altering the system, since possible later users may not be properly informed and may ill-advisedly rely on the precision and safety promised by the manufacturer.

Note

If you determine that the device cannot be operated in a non-dangerous manner, then the device is to be immediately taken out of operation and protected from unintentional use. Taking this action is justified under any of the following conditions:

- I. the device is visibly damaged,
- II. loose parts can be heard within the device,
- III. the device does not work
- IV. the device has been stored for a long period of time under unfavorable conditions (e.g. outdoors or in high-humidity environments).

1. Observe the data in the manual chapter "Technical Specifications", to prevent damage to the unit through inappropriate signal connection.
2. Note when designing your experiments that all input and output leads must be provided with shielding which is connected to the ground ("CHASSIS") at one end in order to ensure high resistance to interference and noisy transmission.
3. Unused, open channels (having no defined signal) should not be configured with sensitive input ranges since otherwise the measurement data could be affected. Configure unused channels with a broad input range or short them out. The same applies to channels not configured as active.
4. If you are using a removable storage media, observe the notes in the imc software manual. Particular care should be taken to comply with the storage device's max. ambient temperature limitation.
5. Avoid prolonged exposure of the device to sunlight.

Due to their function, the imc ARGUSfit modules, just like the CANSASfit modules, are open at the connection points (module connectors). This is not a problem when used in a controlled, dry environment. In order to protect a module (or even a group connected in series) against foreign objects and moisture, please carry out the following measure:

Attach covers over the module connectors on the upper and lower sides.

Two covers per module are fixed at the left side of the module (*parking position*).

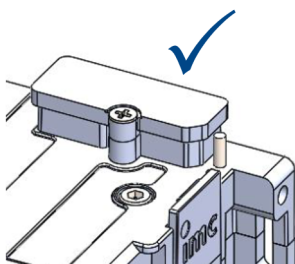

module connector protected
with covering cap

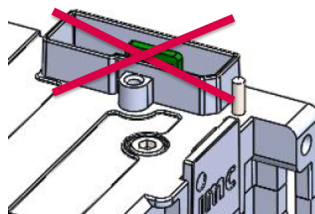

module connector
not protected

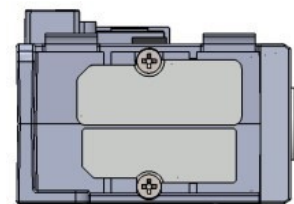

Fig. 1: parking position of
covering caps

3.3.2 Click mechanism

imc ARGUSfit (ARGFT) modules and imc CANSASfit (CANFT) modules can be mechanically and electrically connected by a click-lock, without tools and without additional connecting cables.

The CANFT Module are connected to the system **on the left side of the ARGFT base unit**, see Fig. 2.

ARGFT
base unit

ARGFT modules are connected to the system **on the right side of the ARGFT base unit**.

Further rules, see [Fiber converter](#)^[18] and [UPS](#)^[19]

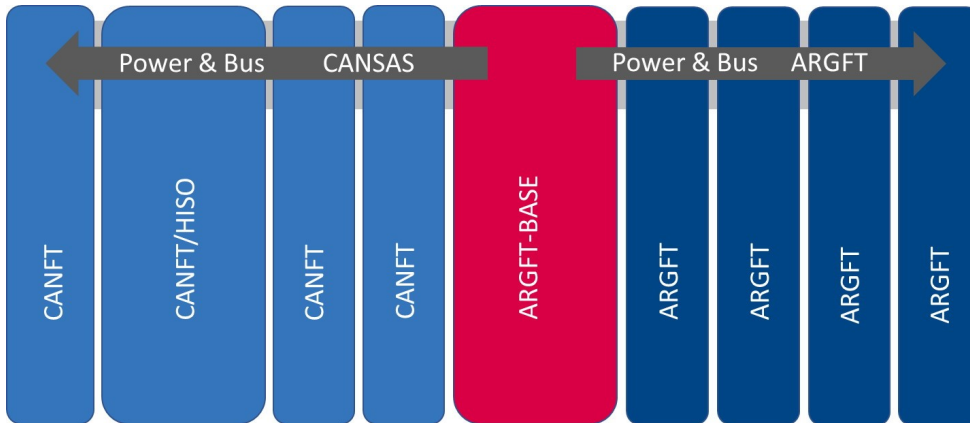

Fig. 2: Order of possible Click connections

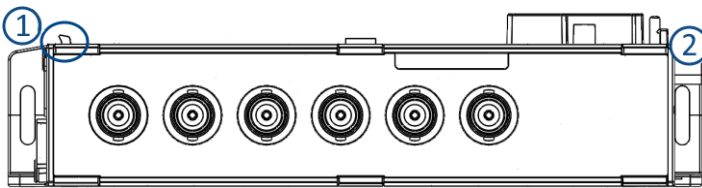

Fig. 3: Locking tongue & locking latch

Stacking the modules

1. Hook tongues into the grooves, see Fig. 3 Position (1) "tongue".
2. Press modules together

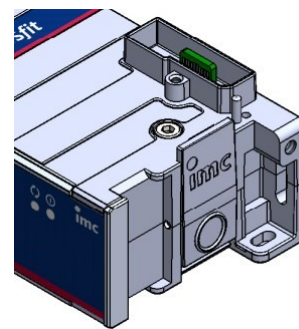
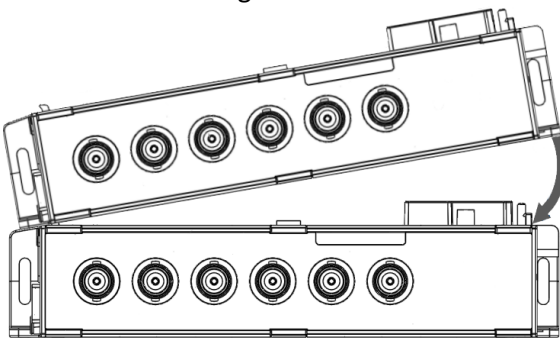

Fig. 4: locking latch

3. To finish mechanical connection, press on the imc Logo (2) on the locking latch. You will hear a click. Now the modules are mechanically locked and electrically connected.

Removing modules from the stack

1. Press the circle on the locking latch, see Fig. 4. You will hear a click.
2. Pull tongues, see Fig. 3 position (1) out of the grooves.

3.3.3 Power supply

An imc ARGUSfit system can be operated with a DC supply voltage that is fed to the overall system via a socket compatible with LEMO.EGE.0B.302 on the base unit ("POWER").

The permissible supply voltage range is 10 to 50 V DC (ultra-wide range). For the AC/DC adapter ("desktop power supply") supplied with the base unit, the specified AC voltage range on the input side is 110 V.. 240 V 50/60 Hz. With regard to EN 61326-1 and EN 61010-1, the DC supply inputs are not specified for connection to a DC mains supply.

Connecting a DC supply source such as a car battery is also fundamentally possible. Please note when making such a connection:

- Grounding of the imc ARGUSfit system must be provided. If the supply voltage source has a ground reference (ground connection to the (-)terminal, then the device is automatically grounded via the (-) terminal. The supplied power adaptor is prepared in this way.
- The supply line must be of low impedance via a cable with a sufficient cross-section. Any (interference suppression) filters in the supply circuit should not contain series inductances greater than 1 mH. should be present. Otherwise, an additional parallel capacitor is necessary.

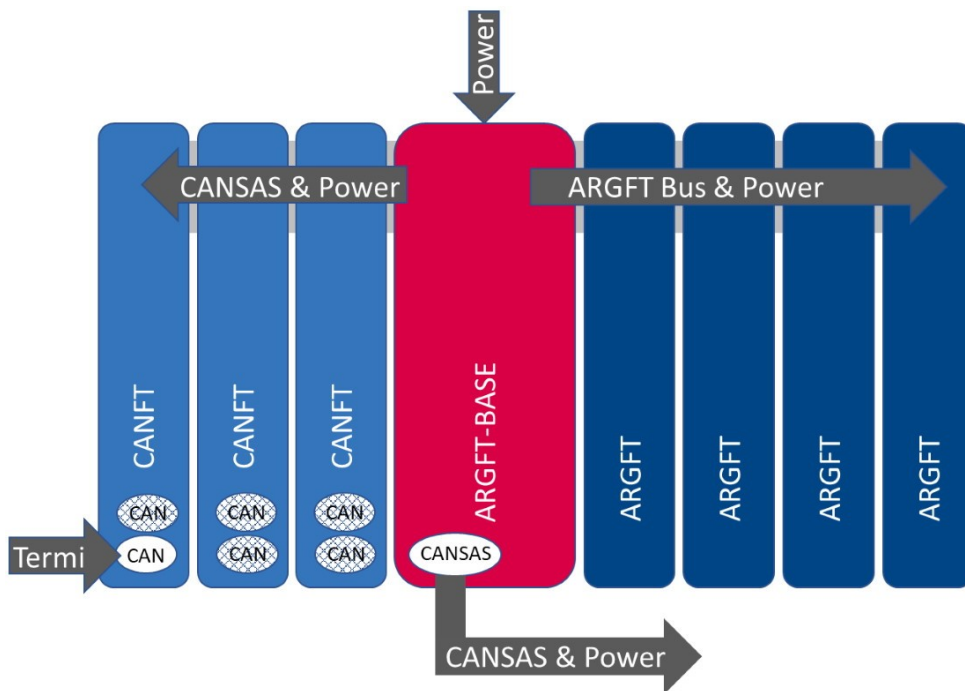

Fig. 5: Power supply via ARGFT base unit

Left

all CANSASfit modules
(CANFT modules)

CANFT



The external **CAN connections** of the CANFT modules "clocked on" to the base unit (CAN node 2) are **switched off**, see Fig. 5.

Base

ARGUSfit Base

CAN node 1 is available on the ARGFT base unit for connecting CANFT modules via a LEMO cable. The 5-pin LEMO socket on the base unit is marked: "**CANSAS**". The CANFT modules connected via this LEMO socket are directly supplied by the ARGFT system supply (is not related to CAN-GND), see Fig. 6¹⁷. A further supply of the CANFT modules is not necessary and must not be carried out (see CANFT topology in the section Commissioning of the imc CANSAS - Modules and Software Manual).

Right

all ARGUSfit modules

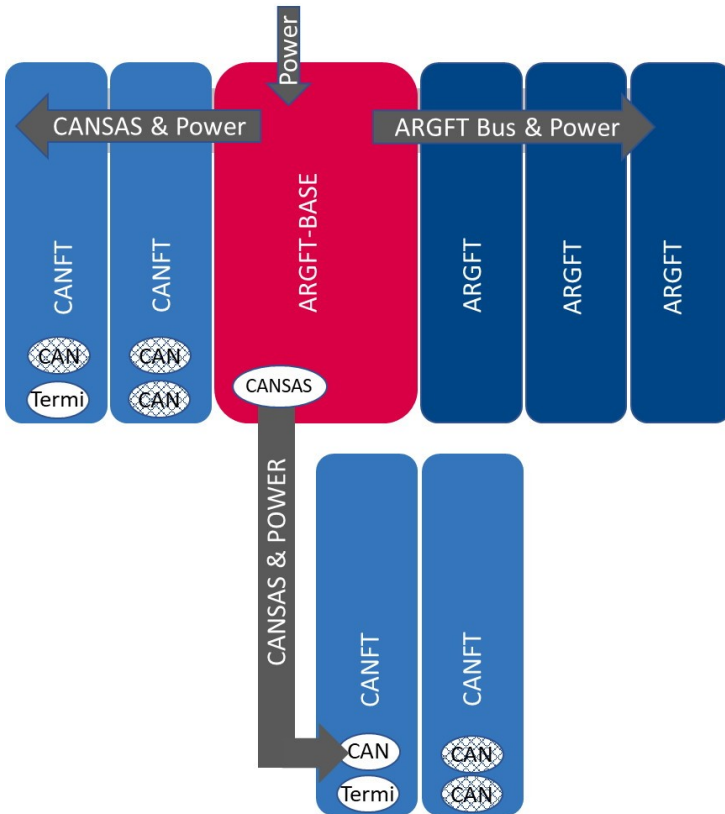

Fig. 6: Power supply of ARGFT and CANFT

Notes

- **Termi:**
The CAN terminator 120 Ω , LEMO.0B plug (ACC/CANFT-TERMI, 13500242) must only be connected to the CANFT module block, which is connected to the base unit (CANSAS) via a LEMO cable, see Fig. 6. The CANFT modules directly coupled to the ARGFT base unit are automatically terminated via ARGFT and do not require a termi.
- Note that the operating temperature of the power supply adaptor is designed for 0 °C to 40 °C. This also applies if your unit should be suitable for an extended temperature range.
- When connecting the power supply, please note that the supply line must be of low impedance via a cable with a sufficient cross-section. Any additional (interference suppression) filters connected in the supply circuit should not contain series inductances greater than 1 mH. Otherwise, an additional parallel capacitor is necessary.

References

- Technical details concerning ARGFT power supply, see manual chapter "Technical Specs" and you can find the pin configuration in [chapter "Power"](#)^[34]
- For an application with the Fiber converter, see [chapter "Fiber converter"](#)^[18].
- For an application with the Power supply (UPS-NiMH) module, see [chapter "UPS-NiMH"](#)^[19].

3.3.4 Fiber Converter

The Fiber Converter is a clickable module for the modular imc ARGUSfit system. It allows decentralized distributed system topologies.

The module converts the internal high-speed ARGUS system bus, which connects the ARGUS measurement amplifier and interface modules via the click connector, to a fiber-optic data link in the sense of a media converter. Thus, the click connection can be extended to a spatially distributed arrangement of the entire ARGUS system by a pair of converters (master/slave) and a fiber optic cable.

The remote module block uses a joint power supply at is fed into the slave converter module.

Fiber converter application

One fiber converter each is clicked onto the right (master) or left (slave) side of an imc ARGUSfit module block. The converters have a uniform design and recognize their master/slave function automatically:

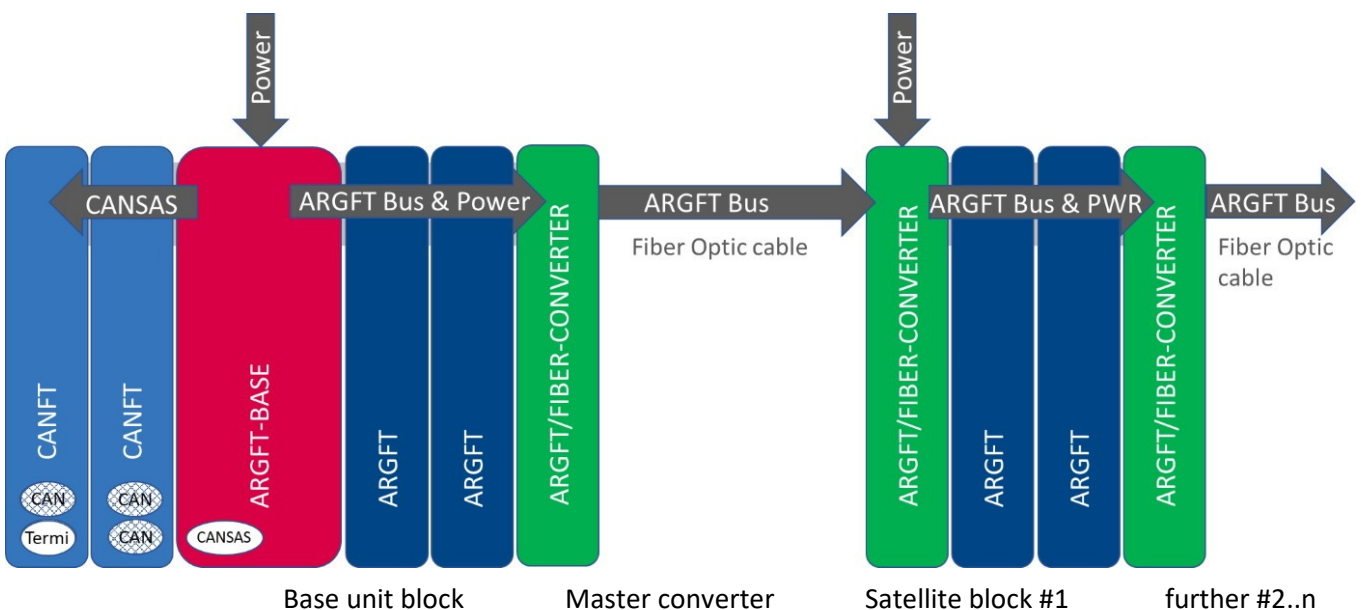

The voltage supply of the base block is realized via the supply socket of the base unit. The power supply of the satellite block (ARGFT module block #1) and possibly further module blocks #2..n is realized via the supply socket of the slave fiber converters clicked onto these module blocks. For this purpose, a DC supply voltage or an AC/DC mains adapter must be connected to the LEMO.0B (2-pin) "POWER" socket of the converter (optional accessory). For these module blocks #2..n, the same specified AC voltage range applies on the input side, as well as the note regarding EN 61326-1 and EN 61010-1 as for the base unit in chapter "[Power supply](#)"¹⁶.

If the slave fiber converter detects no signal activity via the connected fiber cable, it deactivates the power supply of the clicked modules and the slave fiber converter is in sleep mode with reduced power consumption. If signal activity is detected, the power supply for the clicked modules is switched on. Thus, switching off the base unit always leads to switching off the satellite module blocks as well, and the slave fiber converters are put into sleep mode.

Reference

Technical specs for the Fiber Converter, see manual chapter "Technical Specs".

LED functionalities of the Fiber Converter, see manual chapter "Technical Specs / Status- and Power LED".

3.3.5 UPS-NiMH

Powering on/off

The supply module (ARGFT/UPS-NIMH) switches on when

- the module's own pushbutton is pressed and an external supply is applied via the "POWER IN" socket at the same time.
- a pushbutton connected to the module's own "REMOTE" socket is pressed and at the same time an external supply is applied via the "POWER IN" socket.
- a switch connected to the module's own "REMOTE" socket is closed and an external supply via the "POWER IN" socket is applied at the same time.

An imc ARGUSfit-BASE connected to the power supply module receives a shutdown command via the plugged "REMOTE" accessory cable during operation or the power supply module switches off without an imc ARGUSfit-BASE connected when / if

- the module's own button is pressed.
- a button connected to the module's own remote socket is pressed.
- a switch connected to the module's own remote socket is opened.
- *if* an overload case occurs (for details see [section "Output power"](#)^[20] and [section "Output-side overcurrent protection"](#)^[20]).
- *if* the UPS buffer duration has expired or the battery is completely discharged in battery mode.

The supply module switches off with the imc ARGUSfit-BASE connected if

- the imc ARGUSfit-BASE, after being active, has been shut down and has switched itself off.
- the imc ARGUSfit-BASE has still not switched itself off 20 seconds after a shutdown command (error case with the imc ARGUSfit-BASE).

If the power supply module does not respond to all attempts to switch it off, it can be switched off by pressing the module's button for at least 4 seconds. This prevents damage to the batteries due to deep discharge.



Reference

For the power supply module, the same specified voltage range applies on the input side, as well as the note regarding EN 61326-1 and EN 61010-1 as for the base unit in chapter "[Power supply](#)"^[16].

Remote socket

The supply module has a "REMOTE" socket for switching the supply module on and off and a "REMOTE OUT" socket for switching an imc ARGUSfit base unit on and off.

The [assignment of the "REMOTE" socket](#)^[34] is identical to the assignment of other imc supply modules (e.g. imc CRFX/HANDLE-xxx). A static switch (between pin 1 and pin 2) or a push button (between pin 3 and pin 4) can be connected for switching on and off.

A jumper between GND (pin 1/3/5) and -MUTE (pin 6) can be used to mute the internal buzzer of the supply module for buffer operation.

In order for the supply module to switch the imc ARGUSfit-BASE on and off, the corresponding accessory cable must be connected between "REMOTE OUT" and the "REMOTE" socket on the imc ARGUSfit-BASE, see [Fig. 7](#)^[20].

Output voltage for connecting the imc ARGUSfit-BASE and additional measuring modules.

The supply module passes the external supply voltage unregulated to the output. In buffer mode, the internal battery voltage is regulated to approx. 12 V and applied to the output. The supply module has three "POWER OUT" sockets connected in parallel, to which the output voltage for the connected devices is applied. The available output power of the module is divided between all three connections. The assignment is identical with the "POWER IN" socket. In order for the supply module to supply the imc ARGUSfit-BASE, the corresponding accessory cable must be connected between "POWER OUT" and the "POWER" socket on the imc ARGUSfit-BASE, see [Fig. 7](#) ²⁰.

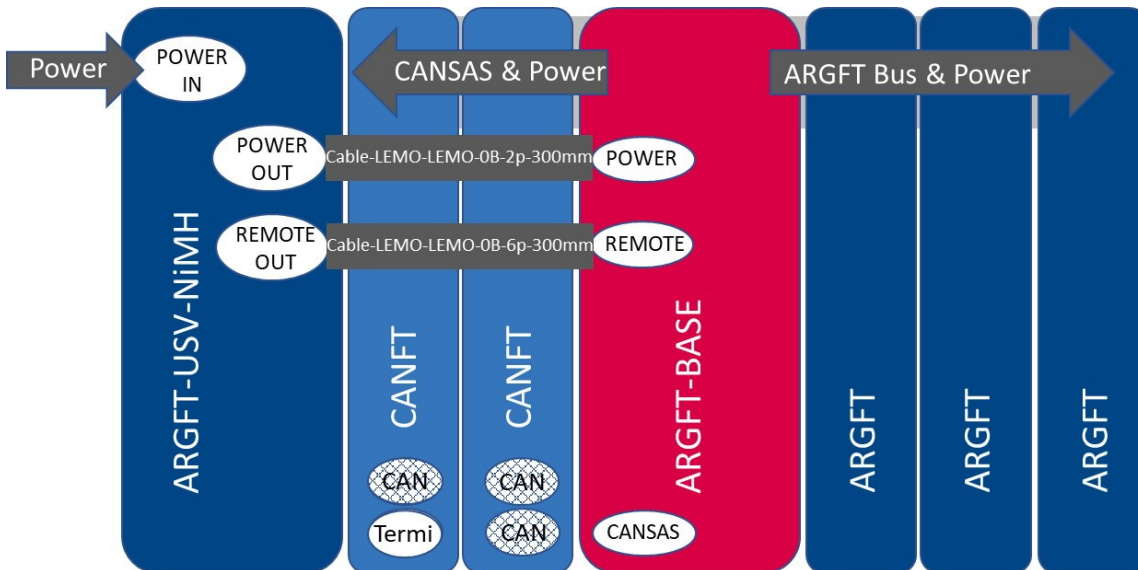

Fig. 7: Power supply via ARGFT/UPS-NiMH (power supply module)

Output power

The supply module has an extended wide range input of 10..50 VDC. In this range an output power of 50 W is available. Below 10 VDC it is switched to battery operation. At low temperatures, the performance of the accumulators is limited, which means that the full output power may not be available in the buffer case. It is reduced by 1 W/K below +15 °C.

Output-side overcurrent protection

Since theoretically any number of modules could be connected to the supply module, the supply module has two independent current limiting circuits to protect the internal circuitry:

1. short-circuit protection (reaction time 10..30 ms)
2. static overload protection (reaction time approx. 1 s)

The **short-circuit protection** limits the output current to a resulting output power of typically approx. 70..85 W, depending on the output voltage. If this limit is exceeded, the output voltage is cut after approx. 10..30 ms and is only enabled again after approx. 4 seconds. If the short-circuit has not been eliminated then, another 4 seconds are waited and so on. During this "waiting" the "LIMIT" LED of the supply module flashes red every second.

The **overload protection** measures the output power every second, evaluates it and will shut down the system in case of a static overload. If the permissible static output power of 50 W is exceeded, a shutdown process is initiated after 10 seconds (after 1 second in the buffer case). The "LIMIT" LED lights up yellow at an output power > 80 % and red at an output power > 95 % of the maximum permissible static output power.

UPS operation

The supply module has a UPS with NiMH batteries. During normal operation with external supply the "POWER" LED is green, during battery operation the "POWER" LED is yellow. A device buzzer is active during UPS operation if pin 1/3/5 are not bridged with pin 6 of the "REMOTE" socket. The maximum buffer duration is fixed at 30 seconds. If the buffer time has expired, the imc ARGUSfit-BASE is shut down if it is connected. If only conditioners are connected, the supply module is switched off immediately after the buffer time has elapsed.

A [4-segment LED display](#)  with battery symbol provides information about the charging status of the UPS. Whether the NiMH batteries are outside the temperature range for charging/discharging is indicated by the color of these LEDs (too cold: blue, too warm: red).

Fuse



The supply module is protected with a non-resettable 10 A fuse at the input.

LED display

The supply module is equipped with two multicolor LEDs and a 4-segment multicolor LED display, which provide information on various operating states:

Parameter	State
Power-LED green yellow red ("LIMIT" LED) and 4 segment display off	Gerät wird über externe Versorgungsspannung 10..50 VDC versorgt Gerät wird über internen Akku versorgt An error has occurred. The following causes are possible: <ul style="list-style-type: none"> • Device has shut down, but may not power up, e.g. due to closed remote switch. • internal error
"LIMIT"-LED green yellow red red flashing red and blue flashing alternately	instantaneous output power at less than 80% of the permissible output power instantaneous output power between 80% ... 95% of the permissible output power Instantaneous output power above 95% of the permissible output power; there is a risk of forced shutdown due to overload the short-circuit protection of the device has deactivated the output voltage for 4 seconds; the output voltage is then switched on again. The instantaneous output power is greater than the output power to be throttled due to low battery temperature. A sufficiently long buffer operation may not be available!

4 segment LED display	State
	Each segment represents 25% of the full battery capacity. When the battery is being charged, the rightmost of the illuminated state-of-charge segments flashes green at one-second intervals. In contrast, the warning signal when the battery is very far discharged (<10%) is characterized by the fact that only the left segment is lit and flashes at a faster interval.

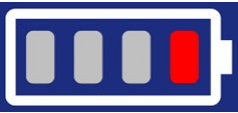
4 segment LED display	State
	<p data-bbox="475 286 751 342">💡 Example</p> <p data-bbox="491 360 1422 427">The battery capacity is 50..74 % and the battery is in its allowed temperature range for charging and discharging.</p>
	<p data-bbox="448 465 1469 533">The battery temperature is too warm and is above the limit. Buffer operation is only possible for 10 seconds, charging is not possible.</p>
	<p data-bbox="448 584 1437 651">The battery temperature is too cold and is below the limit value. Buffer operation may only be possible for a short time and charging is not possible.</p>
	<p data-bbox="448 703 1214 736">Internal error of the UPS, buffer operation may not be possible.</p>

3.3.6 Powering on

Press the on/off button  on the base unit for approximately 1 s.

Reference

If you use a **Fiber Converter** (ARGFT/FIBER-CONVERTER), please be sure to read [chapter "Fiber Converter"](#)  ¹⁸.

If you use a **supply module** (ARGFT/UPS-NIMH), please be sure to read [chapter "UPS NiMH"](#)  ¹⁹.

3.3.7 Powering off

The system is switched off by pressing the on/off button again (for approx. 1 s). 

The unit does not switch off immediately during a measurement. First, the corresponding files on the internal hard disk are closed before the device switches off automatically. This process takes a maximum of about 10 s. It is not necessary to press the power-on button continuously during this time. If no measurement is running, the switch-off process takes approx. 1 s.

Reference

If you use a **Fiber Converter** (ARGFT/FIBER-CONVERTER), please be sure to read [chapter "Fiber Converter"](#)  ¹⁸.

If you use a **supply module** (ARGFT/UPS-NIMH), please be sure to read [chapter "UPS NiMH"](#)  ¹⁹.

3.3.8 Remote control of the base unit

As an alternative to the manual on/off button on the front of the base unit, an electrically remote-controllable contact on the remote socket can be used to switch the base unit and all modules connected to the base unit on and off.

Reference

Pin configuration of the LEMO socket, see [chapter "Remote"](#)  ³⁴.

If you use a **supply module** (ARGFT/UPS-NIMH), please be sure to read [chapter "UPS-NiMH"](#)  ¹⁹.

3.3.9 Internal data carrier

This chapter describes details of the internal data carriers and how to operate them.

For saving measured data, some devices support an internal storage medium. Depending on the device type, this storage medium could be a removable drive (see "*Device overview*").

Note

The functional capabilities depend on both the model and production date. A list of all device types and their distinctive properties is presented in a list in the "*Device Overview*".

Swapping the Storage Medium

Pressing the button signals to the system that you intend to remove the storage medium. Once this is done, the device stops access to the storage medium. If you were to remove the drive without prior announcement, it could produce defective clusters. And if you were to remove the storage medium while a measurement is running, the waveforms would be incomplete! Therefore, always proceed as follows when swapping the storage medium:

1. Press the button.
2. Once the LED blinks, remove the storage medium.
3. Insert the new data carrier. Devices indicate by a short flash that the new drive has been successfully recognized.

Errors in accessing the Storage Medium

Errors can have the following causes, among others:

- The data rate is too high, the storage medium can't keep up and data overflow results.
- The storage medium is full.

The device signals any error by flashing this LED. Its further responses depend on whether or not the device is connected to the PC.

- If no PC is connected, for instance in cases involving automatic self-start capability, the **button lights continuously**. At the end of an experiment, always check for this if measurements are taken without PC aid.
- If the PC is connected to the ARGFT base unit, imc STUDIO documents the error with an **message in the Logbook** and switches the LED off. Any one-time data overflow only shows up in the Logbook, since the LED is reset afterward's . If data overflow occurs repeatedly, The LED is activated again, the PC records the message again, and as a result the LED **blinks intermittently**.

Hot-Plug (Exchanging the Storage Medium during a measurement)

It's possible to exchange the storage medium during a running measurement. This makes it possible to carry out a measurement without a PC practically without any limitations. It is only necessary to check the amount of memory available using imc Online FAMOS. To do this, use the function `DiskFreeSpace` belonging to the group "*System*". You can set an LED, for instance, or a digital output or a beeper to be activated when less than the minimum amount remains. One convenient solution would be to have a readout of the remaining space outputted by a display variable, which would indicate by a display on the device how the remaining memory decreases.

While swapping the storage medium during a running measurement, the data are stored in the measurement device's internal memory. If you complete the process within the specified RAM buffer duration, this is certain to work without any loss of data (see Chapter "*RAM buffer time*"). Note that not only the time for the swap must be buffered, but that the buffered data must also be transferred to the new disk once the swap has been completed.

Swapping the storage medium

1. **IMPORTANT!** Before removing the storage medium from the measurement device, first announce the procedure to the system by pushing the button, in order to avoid data loss and damage to the storage medium. The LED will **shine continuously** in green.
2. Once the device is ready for removal of the storage medium, the LED **blinks**.
3. Remove the already full storage medium.
4. No announcement is necessary for inserting a storage medium.

3.3.9.1 Memory volumes

Storage media	Description
microSD	<ul style="list-style-type: none"> • Only microSD memory cards tested by imc may be used, as these have been specially qualified by us for our high data rate of 5 MS/s. • The specified operating temperature range of the media is relevant.

Recommended microSD storage media available at imc		
Order Code		article no.
ACC/MICROSD-512GB-ET	microSD Flash memory card 512 GB	135000xx
ACC/MICROSD-256GB-ET	microSD Flash memory card 256 GB	13500042

3.3.9.2 Data transfer

a) Retrieving data with the PC connected

Normal procedure. This is the fastest method for small data volumes.

- Using the Explorer, copy the data from the internal storage medium.
- Erase the contents of the storage medium.

b) Retrieving data via modem

Remote data retrieval. Can take a long time if the data volume is correspondingly large.

- Like a) only connected via modem

c) Copying storage medium via the card reader of a PC

Suitable for large data volumes due to the high-speed transfer.

1. Insert storage medium into the PC-slot.
2. Use Microsoft Explorer to copy the storage medium's data.
3. Erase the contents of the storage medium.
4. Insert storage medium back into the imc device.

Warning

- Do **not use force** to insert or remove the device storage medium.
- During a **running measurement** having a high sampling rate, you should **never** try to **access the storage medium in the device** using the Windows Explorer shell. Otherwise, this additional burden could cause a data overflow.

Note

A tip on **interval saving**: Supposing the system's power supply suffers an outage during a measurement, it would not be possible to guarantee that the data file on the storage medium is terminated properly. This may lead to a failure to record the last measurement taken. Saving at intervals is a way to reduce this risk (see chapter "*Saving Interval*").

3.3.9.3 Access via Windows Explorer

The menu item "Data (Device)" (📁) causes the Windows-Explorer to start while indicating the device selected.

Ribbon	View
Extra > Data (Device) (📁)	Complete
Home > Data (Device) (📁)	Standard

For devices of the firmware group imc DEVICEcore - Devices of groups B10 and up:

Using this menu item, a separate Windows-Explorer is opened for each device, providing direct access to the internal memory.

For the purpose of accessing the tool, it is necessary to log in. The factory default settings are:

- User: "imc"
- Password: device serial number

Manual entry

The device is called by reference to either its IP address or its internal name. The device's name is constructed as follows: "imcDev" + SerialNumber; e.g.

\\imcDev4120110

\\10.0.12.70

3.3.10 LED display ARGFT-BASE

• Mess-Status	STATUS	LED für Gerätezustand
---------------	--------	-----------------------

Quittierung des microSD Auswurf: durch die Status-LED

Signalisierung LED-Anzeigen ARGUS BASE	
Modul-Zustand	Status LED
ausgeschaltet	aus
ausschalten	aus
Init	gelb
Ready	grün
Config	gelb
Armed	blau
Record (Messung)	blau blinken 1 sec
Micro SD Quittierung	(blau doppelt blitzen)
Firmware Update	magenta
Error	rot

4 Maintenance and servicing

4.1 Maintenance and servicing

No special maintenance measures are required. Corrective repair work may only be performed at factory by imc Test & Measurement GmbH.

There are a number of important device characteristics which should be subjected to precise checking at regular intervals. We recommend annual calibration. Our calibration procedure includes calibration of inputs (checking of actual values of parameters; deviations beyond tolerance levels will be reported), a complete system-checkup, newly performed adjustments and subsequent calibration (the complete protocol set with measurement values is available at an extra charge). Consult our Hotline for the price for system calibration according to DIN EN ISO 9001.

For questions by telephone, please be prepared to provide your device's serial number and have your imc installation software, as well as this manual, at hand; thanks! The serial number, necessary power supply, interface type and software version included can be determined from the plaque on the side of the device.



The specified maximum errors are valid for 1 year following delivery of the device under normal operating conditions (observe operating temperature).

4.2 Cleaning

Disconnect the device from all circuits before cleaning. Only qualified service technicians are permitted to clean the housing interior.

Do not use abrasive materials or solutions which are harmful to plastics. Use a dry cloth to clean the housing. If the housing is particularly dirty, use a cloth which has been slightly moistened in a cleaning solution and then carefully wrung out. To clean the slits use a small soft dry brush.

Do not allow liquids to enter the housing interior.

4.3 Storage

As a rule, the measurement device must be stored in a temperature range of -40°C to +85°C.

4.4 Transport

When transporting, always use the original packaging or a appropriate packaging which protects the device against knocks and impacts. If transport damages occur, please be sure to contact the imc Customer Support. Damage arising from transporting is not covered in the manufacturer's guarantee. Possible damage due to condensation can be limited by wrapping the device in plastic sheeting.

5 Start of operation Software / Firmware

5.1 Installation - Software

The associated measurement engineering software imc STUDIO, the configuration and operating interface for all imc instruments, provides the devices with exceedingly versatile functionality. It achieves comprehensive total solutions for everything from laboratory tests through mobile data logger application all the way to complete industrial test stations.

Use of the software requires a license, subject to the purchase order and configuration (see e.g. imc STUDIO manual product configuration / license).

In order to be able to install or uninstall imc STUDIO products, you must be registered with a user account possessing administrator rights to the PC. This applies to the overwhelming majority of all installations of Windows. However, if you are only logged on to your PC without administrator rights, log off and log back on with an administrator user account. If you do not possess an administrator user account, you will need the support of your system administrator or IT department.

You will find a detailed description to the installation of the software in the adequate manual or getting started.

5.1.1 System requirements

The minimum requirements of the PC, the recommended configuration for the PC, the supported operating system are mentioned in the data sheets and the imc STUDIO manual.

5.2 Connect the device

There are multiple ways to **connect the imc measurement devices with the PC**. In most cases, the **connection via LAN** (local area network, Ethernet) is implemented. See chapter "[Connecting via LAN in three steps](#)" for the **quickest way to connect** PC and measurement device.

But there are also other connection types:

- WLAN
- LTE, 4G, etc. (via appropriate routers)

These are described in a separate chapter in the software manual: "*Special options for connecting to the device*".

The devices use the **TCP/IP protocol** exclusively. With this protocol, some settings and adaptations for your local network may be necessary. For this purpose, the support of your network administrator may be necessary.

Recommended network configuration

Please use up-to-date, high-performance network equipment in order to achieve the maximum transfer bandwidth. This particularly means 100BASE-T (Fast Ethernet 100 MBit/s) or 1000BASE-T (Gbit Ethernet). Gbit Ethernet network equipment (switch) is backwards compatible, so that it can even be used to operate such imc devices which only support 100 MBit Fast Ethernet, but not also Gbit Ethernet (such as CRXT or CRFX-2000GP).

The cable length between the switch and a PC or a device should be less 100 m. Use a shielded cable. If the length of 100 m is exceeded, then you have to insert another switch.

If the system is being integrated into an existing network, you must ensure that the minimum data rate can be guaranteed. Under some circumstances, this may require using switches to subdivide the network into separate segments in order to govern the data traffic in a targeted way and thus optimize the data rate.

In very demanding applications, you might consider grouping multiple GBit Ethernet devices via even higher-performance sections lines of the network (e.g. via 5 GBit Ethernet) and to connect these groups to NAS-components, for instance, via these lines.

When such imc devices are included which use network-based PTP-synchronization (e.g. CRXT or CRFX-2000GP), then it is necessary to use network switches which fully support this protocol on the hardware side. Appropriate network components are also available as imc accessories (e.g. CRFX/NET-SWITCH-5) and are then electrically and mechanically fully compatible with the imc systems.

5.3 Connecting via LAN in three steps

The most common case is described below: the PC and the device are connected via cable or network switch. The device's IP address must be set in the PC's address range. Subsequently, the device can be connected with the PC. If a connection has ever been established previously, the software recognizes the device's hardware configuration. In that case, experiment configurations can be prepared without any connection to the device.

Step 1: Connecting the measurement device

To connect via LAN there are two options:

1. The measurement device is connected to an **existing network**, e.g. via network switch. Only with a switch is it possible to run multiple devices.
2. The measurement device is connected directly to a network adapter on the PC (**point-to-point**).

In a LAN, the first case is typically implemented. Modern PCs and network switches are usually equipped with Auto-MDI(X) automatic crossover recognition, so that it is not necessary to distinguish between crossed and uncrossed connection cables. Thus both cable types can be used.

Step 2: IP-configuration

Start device. Open the dialog for configuring the device IP address by clicking on the button "*Device interfaces*" ().

Ribbon	View
Setup-Configuration > Device interfaces ()	Complete

If this **button is not present** in the view, it is also possible to open the dialog after a device search if it failed to find any new devices. Subsequently, a prompt appears asking whether to search for devices with an inappropriately configured network interface. Close this message box by clicking "Yes".

Once the dialog starts, the system automatically searches for all devices in the network. In the tree diagram, all available devices are indicated. If the device appears among the group "Currently not reachable" ①, it is necessary to modify the device's LAN-settings. If the device appears among the group "Ready for measurement" ②, you can leave the settings as they are or review them.

Select the device for making modifications ③.

If there is any IP-conflict, devices affected will not be listed.

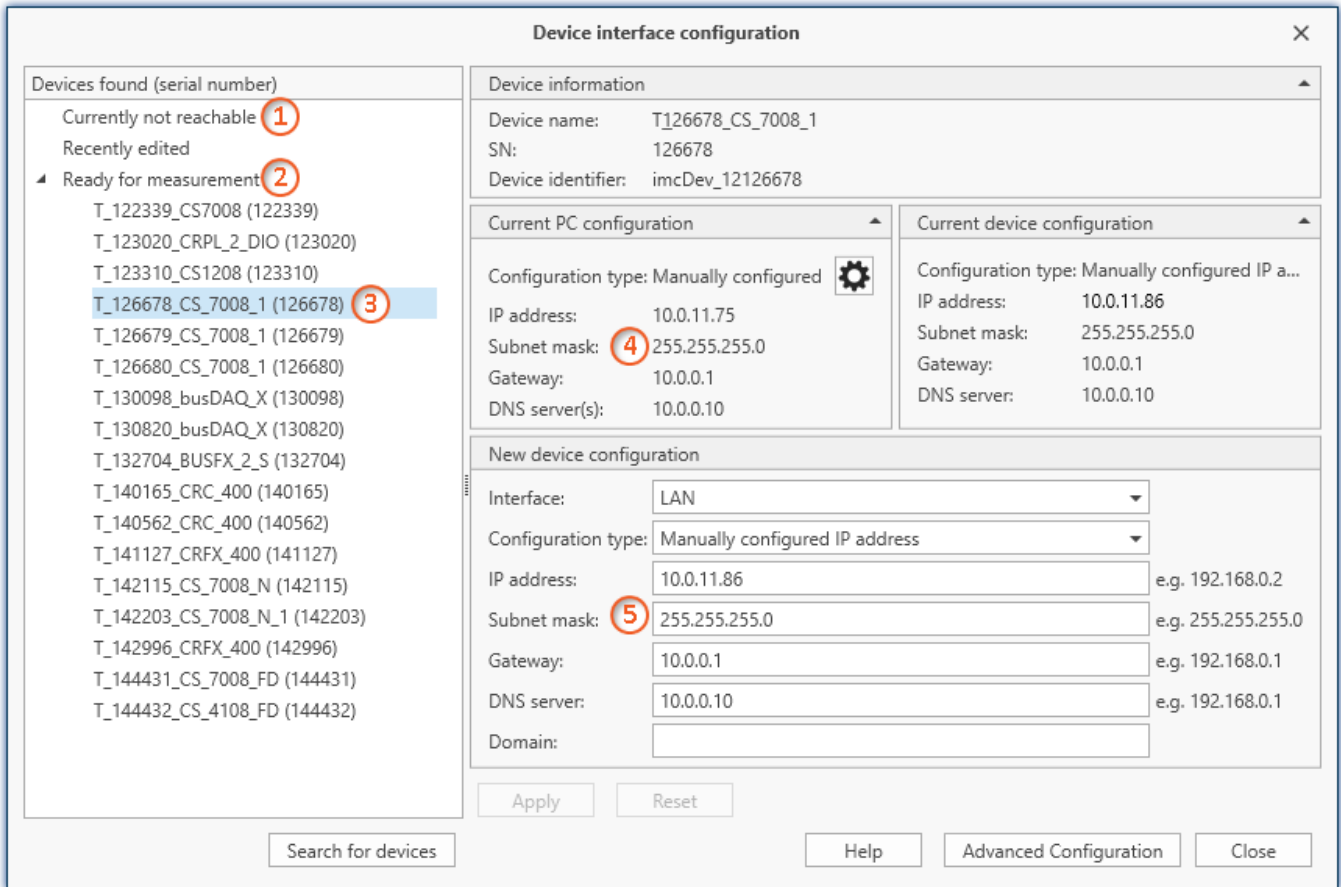

Display of measurement devices found and of the IP address

Set the **IP address manually** if you are not using DHCP. The device's IP address ⑤ must match with the PC's address ④. To conform to the network mask, only the device portion may be different (see example).

Example

In the example shown, the fixed IP 10.0.11.75 with subnet mask 255.255.255.0 is selected for the PC. For measurement devices, any numbers would be suitable which begin with 10.0.11. and then do not contain 0, 75, or 255. The 0 and the 255 should not be used, if possible, due to their special significance. The 75 is the computer's number.

Example for IP settings	PC	Device
IP address	10 . 0 . 11 . 75	10 . 0 . 11 . 86
Network mask	255 . 255 . 255 . 0	255 . 255 . 255 . 0



If the configuration type: "DHCP" is used, **the IP address is obtained automatically** from the DHCP-server. If it is **impossible to obtain any setting values** via DHCP, the **alternative values are used**. These could lead to errors in the connection (different networks, same IP addresses, etc.).

If there is a **direct connection** between the device and the PC by a cable, then **DHCP should not be used**.

In order to apply the changes, click on the button "Apply". Wait for the device to restart and then close the dialog.

Step 3: Integrating a device into an experiment

Now you are ready to add the device to the device experiment. If your device is unknown to the system, first perform the "device search".

Ribbon	View
Home > Search for devices ()	all
Setup-Control > Search for devices ()	Complete

Select the desired device: Once you click in the checkbox "Selected" for the desired device, it is ready to use in the experiment.

Selected	Device name	SN	Device specification
<input checked="" type="checkbox"/>	T_124835_C1_1_LEMO_ET	124835	imc C1-1 LEMO
<input type="checkbox"/>	T_130039_busDAQ_X	130039	busDAQ-X
<input type="checkbox"/>	T_130311_SPARTAN_U32_CAN	130311	imc SPARTAN

You can also select multiple devices for your experiment.

Now the device is "known". After the next program start it is available for selection. For further information, see the documentation on the component "Setup".

5.4 Firmware update

Every software version comes with matching firmware for the hardware. The software only works with devices having the right firmware.

Once the program connects up with the unit, the device's firmware is checked. If the software version doesn't match the device's firmware version, you are asked if you want to perform a firmware-update.

Note

The firmware update is only required if the software was obtained as an update. If you obtained your hardware equipment together with the software, no firmware update is necessary.



Warning

Do not interrupt the firmware update!

Be absolutely certain to observe the following:

1. Under no circumstances should the device or its power supply be deactivated during the firmware update!
2. The network connection may not be interrupted. Use a cable connection, not WLAN!

Upon the connection/preparation, the versions are compared. If they do not match, the next dialog notifies you about this, and indicates both which version is being used and which version is required.

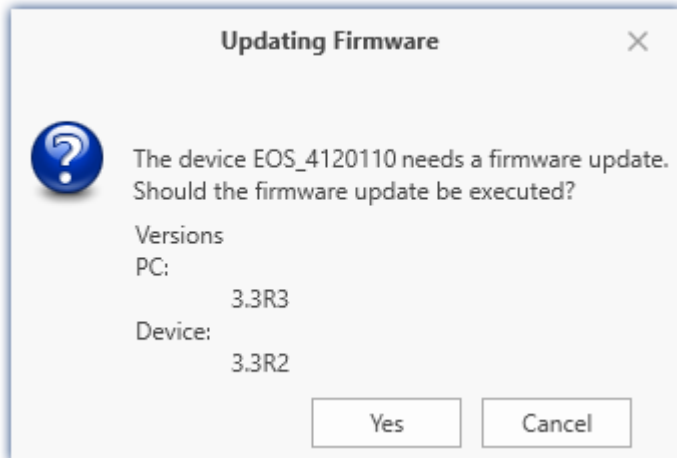

When you click "Yes", the firmware update starts. The duration of the update depends on the amount of amplifiers (can last up to several minutes). You will be informed on the progress.

The system notifies you when the firmware update has been completed successfully. Close the dialog. Subsequently the device can be used with the device software.



What to do in case of an error occurring in a firmware update?

Answer: When a firmware update fails to run correctly, the last active firmware is restored. The device remains operational by means of the previous installed firmware. Repeat the procedure, and if the repeat procedure also fails, please contact the imc-Hotline.

What is an optional update?

Antwort: In some cases, a firmware update is not mandatory. In such cases, the update is available to you as "*optional*". However, we still recommend performing the update, since every update not only implements improvements, but also fixes any bugs. Nevertheless, with the new version of imc STUDIO, you are able to work with the device running the old firmware edition, if you choose.

6 Pin configuration

6.1 Power

The base unit, the fiber converter and the UPS module are all equipped with a "Power" socket on the front in order to supply the connected module block with power.

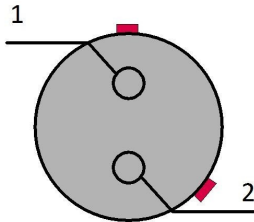

Fig. 8: Socket for the power supply
(view on top of the socket)

PIN	Signal
1	+Supply
2	-Supply

There is a red mark on the side of the positive pole.

6.2 Remote

Both the base unit and the [UPS module](#)^[19] are equipped with a "remote" socket on the front. Please read the chapter "[UPS-NiMH](#)^[19]" carefully before using the UPS module.

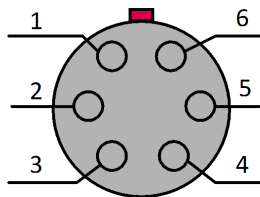

Fig. 9: Remote socket
(view on top of the socket)

PIN	Signal
1	GND
2	remote switch
3	GND
4	remote push button
5	GND *
6	MUTE *

* only in the REMOTE socket of the [UPS module](#)^[19]

Remote On/Off

Switching on/off the base unit and all [modules connected to the base unit](#)^[15] can be done via the remote connection in addition to the [on/off button](#)^[23]. The following functions are available:

Note

Remote switch (pin 2)

Bridge remote switch (**pin 2**) with GND to switch on/off.

If this connection is **permanently** bridged, the base unit can be switched on or off automatically via the supply voltage. If a self-start configuration has been stored in the unit, it can be used, for example, to automatically start a measurement in the vehicle when the board voltage is switched on.

Note

Remote push button (pin 4)

Briefly bridge remote push button (**pin 4**) with GND to switch on/off.

6.3 Base Unit

6.3.1 GPS

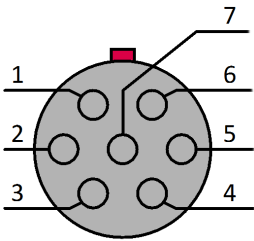

Fig. 10: GPS socket
(base unit)
(view on top of the socket)

PIN	Signal	
1	VCC	4.2 V - 5 V / 300 mA
2	RxD	
3	TxD	
4	CTS	
5	GND	
6	RTS	
7	1 ppm	

6.3.2 CANSAS

This LEMO socket "CANSAS" (size 0B) on the front of the ARGFT base unit is intended exclusively for imc CANSASfit (CANFT) modules. The ARGFT supply POWER is passed through to supply the CANFT modules (CAN-SUPPLY).

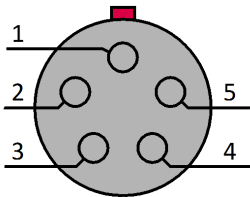

Fig. 11: Socket to connect
CANFT modules
(view on top of the socket)

PIN	Signal
1	+CAN-SUPPLY
2	-CAN-SUPPLY
3	CAN_H
4	CAN_L
5	CAN_GND

Reference

[Description: chapter Assembly and connection](#) ¹⁵

6.4 Measurement Modules

6.4.1 UTI-6

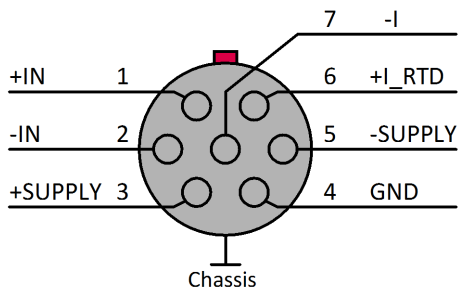

Fig. 12: UTI-6-SUP socket (pinning)
(view on top of the socket)

Figures

Figure 1: parking position of covering caps	14
Figure 2: Order of possible Click connections	15
Figure 3: Locking tongue & locking latch	15
Figure 4: locking latch	15
Figure 5: Power supply via ARGFT base unit	16
Figure 6: Power supply of ARGFT and CANFT	17
Figure 7: Power supply via ARGFT/UPS-NIMH (power supply module)	20
Figure 8: Socket for the power supply	34
Figure 9: Remote socket	34
Figure 10: GPS socket (base unit)	35
Figure 11: Socket to connect CANFT modules	35
Figure 12: UTI-6-SUP socket (pinning)	36

Index

4

4 segment LED display 21, 22

A

Accessing the data carrier 24

Add device 32

C

Cables 7

CE 7

CE Certification 5

Certificates 5

Cleaning 28

Click mechanism 15

connect device 30

Connecting via LAN 30

Customer Support 5

D

Data transfer

Storage medium 26

Device

add 32

connect 30

DIN-EN-ISO-9001 5

E

ElektroG 7

EMC 6

F

FCC 7

Firmware update 32

G

General terms and conditions 5

Grounding 16

Guarantee 5, 6

H

Hotline 5

Hot-Plug

Storage medium 24

how to connect 15

I

imc STUDIO 29

operating system 29

Industrial safety 11

Industrial safety regulation 11

Installation

imc STUDIO 29

IP address

configure 30

of the devices 30

of the PCs 30

ISO-9001 5

L

Leads 7

LED

Base 27

Power (UPS) module 21

Liability restrictions 6

Limited Warranty 5

M

Maintenance 28

MicroSD Storage medium 25

module connector 15

O

Operating personnel 10

P

Power supply 16

Q

Quality Management 5

R

RoHS 7

S

Safe operation 14

Service: Hotline 5

Software installation 29

Special hazards 11

Storage 28

Storage medium

Data transfer 26

Hot-Plug 24

MicroSD 25

Swapping the storage medium 24

System requirements 29

T

Telephone numbers: Hotline 5

Transport 28

W

Warranty 5

WEEE

Restriction of Hazardous Substances 7



è una divisione di
Instrumentation Devices Srl
tel.+39 031 525 391
info@imc-italy.com - www.imc-italy.com



Instrumentation Devices Srl
Via Acquanera 29 - 22100 COMO (Italy)
tel.+39 031 525 391
info@instrumentation.it - www.instrumentation.it